

Automatic storage



明盛倉

MINGSHENG STORAGE

*We Build The Storage Systems That
Fit Your Products*





全面仓储方案专家

Professional warehouse solution

公司简介

本公司是国内最早从事仓储物流设备的大型专业化制造型企业，具有从咨询设计、制造销售、安装调试及售后维护全方位一条龙服务的综合能力。现有厂区占地35000平方米，现代化标准厂房面积25000平方米。公司具有雄厚的技术力量和产品开发能力，先进的生产设备，成熟的加工工艺及完善的质量保证体系。公司地址江苏省常州市横林镇，紧邻沿江高速、沪宁高速和312国道，交通十分便利。

公司在引进、运用国外先进技术的基础上自主研究开发，不断创新进取，全面优化产品结构，贯彻国际行业标准，严格按ISO9001质量标准控制产品生产全过程，力争产品质量与国际市场接轨。产品适应性强，性价比高，服务完善，种类齐全，有中型货架、重型货架、阁楼货架、贯通货架（驶入式货架）、悬臂货架、滚轮式货架、重力式货架、窄巷式货架、钢托盘、物料箱、物流推车、堆垛架、仓储笼、工作台、隔离网、工位器具系列及非标金属结构件和物流周转器具的设计和制作，所有产品都符合行业安全和质量标准。“明盛”产品以领先的技术，精湛的质量、良好的信誉，优惠的价格、完善的服务，在国内和国外拥有众多客户，享有很高的声誉。

客户满意是我们最大的目标，期待与您的合作！

Tel:0519-88786788/88787978

Fax:0519-88780111

Http:www.msjscn.com

Email:company@msjscn.com

ChangZhou MingSheng Storage Equipment Co.,Ltd,---as an earlier national company that specialized in manufacturing storage equipment. We provide comprehensive business service, from product design、sales、 installation and debugging of racks for industrial warehouse. We could give you a turn key project service, Now the factory covers 35000 square meters manufacturing and warehouse areas.The company has rich experience, advanced developing methods, high production equipment and high quality standard.

We are mainly dealing in :light and heavy duty rack system ,mezzanine rack, drive-in rack, cantilever rack ,roller rack, gravity rack, VNA rack, steel pallets, plastic pallets, crates ,manual trolley, stack unit rack, foldable mesh box pallet, working table ,isolated mesh, station equipment and necessary equipment .They also provide the best after-sales service solution.

To keep its steps along with international speed ,We produce product according to the quality standard of ISO9001.The company provides you with the outstanding technology、 good quality、 competitive price ,so it enjoys the highest reputation not only from national but also from the worldwide.

Please believe that they are the best collaborator for you!

MINGSHENG STORAGE EQUIPMENT CO.,LTD.
MINGSHENG STORAGE EQUIPMENT CO.,LTD.

目录 CATALOGUE



轻量型货架 >>P2
LIGHT-DUTY RACKING



重力式货架/推入式P18
GRAVITATION RACKING



中量型货架 >>P3-5
MEDIUM-DUTY RACKING

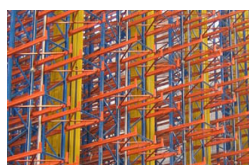

自动化立体仓库 >>P19
AS/RS SYSTEM



悬臂式货架 >>P6
CANTILEVER RACKING



移动式货架 >>P20
MOVABLE RACKING



重量型横梁货架 P7-10
HEAVY DUTY PALLET RACKING

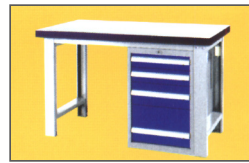

工作桌/工具柜 P21-22
WORK TABLE



阁楼式货架 P11-P12
MEZZANINE RACKING

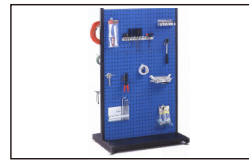

物料整理架 >>P23
登高车、推车
HANGER RACK / CART



贯通式货架 >>P13-14
DRIVE-IN RACKING



物流周转箱/堆垛架 >>P24
PLATFORM RACKING



流利式货架 >>P15
ROLLER RACKING

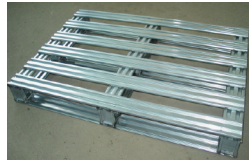

托盘系列 >>P25-27
PALLET



模具货架 >>P16
MODULE RACKING



钢格板 >>P28
GRATING



窄巷式货架/围网 >>P17
VNA RACKING



专用物流器具 >>P29
LOGITICS TOOL SERIES

货架常用色



电动堆高机系列 >>P30
ELECTRIC FORKLIFT

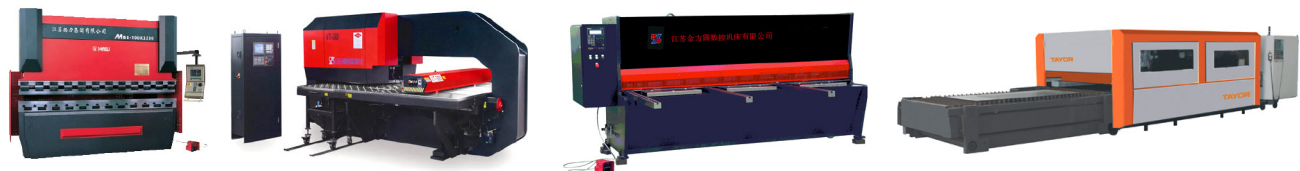

技术参数(specification)

长度length	900, 1200, 1500, 1800 mm
深度depth	450, 600 mm
每层最大层载 maximum load each layer	50, 100, 150kg
立柱规格 upright specs	38 × 38 × 2mm, height: 1.5, 2, 2.5meter,
表面处理 surface treatment	喷塑/镀锌 plastic coated/ galvanized

产品特征:(Feature)

该货架结构采用层板与角钢立柱通过角码连接而成，具有自重轻，安装方便，可自由组合，层高可调等特点。

This shelf is consist of board and angle steel upright posts, installed by pinlock, the advantage is light weight, medium duty, assemble freely ,the adjustable height.



产品特性:

该货架结构采用挂板与层板结合的结构形式,可承载较大的载荷,横梁有多种规格的断面,插接式结构,组合灵活,拆装简便,层数可按需要增减,层高可调整,调节间距为50mm

The structure type combined with the beams and shelves and boards ,it can bear the heavy load ,the beam has the sections of various specifications ,the structure can be assembled freely assemble freely ,the height of layer can be adjusted with the distance of 50mm.

VI型货架

立柱规格: 55x55x1.5/1.8

承重: 300kg/层

可调间距50mm

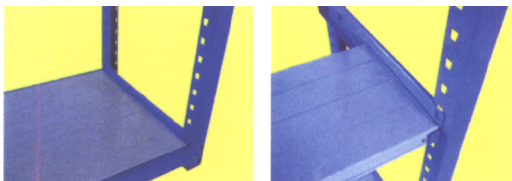



- ◇ 组装、拆卸简单，用于放置体积较大的货物
- ◇ Easily be assembled and disassembled, used to store big volume goods
- ◇ 外形美观大方，并可用于搭建阁楼货架
- ◇ Good appearance, could be used to establish multi-tier
- ◇ 适用于人工存取货物
- ◇ Suitable for manual picking and stocking
- ◇ 承载100Kg—800Kg/层
- ◇ Loading capacity is 100Kg—800Kg/Level
- ◇ 以50mm为步距上下调整
- ◇ Adjustable by 50mm a step

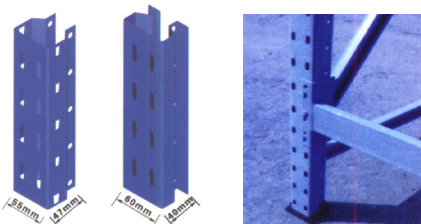

V型货架:

立柱规格: 60x40x1.5/1.8
55x47x1.5/1.8
横梁规格: 40/60x30/50x1.5/1.8/2.0
承重: 200-500kg/层
可调间距50mm



技术参数(specification)

高度(height)	1500	1800	2000	2500	3000	3500	4000
深度(depth)	400	450	500	500	600	700	800
长度(length)	1200	1500	1800	2000	2300	2500	2500



汽车4S店专用货架大多采用阁楼和中型货架，另外根据一部分汽车配件的特别形状，设计了适合其储存的专用货架。汽车4S店货架根据存放的配件形状订制货架分为：轮胎架、玻璃架、挂件架、排气管架、消声器架等

Auto Car 4S store rack system, the parts mostly all choose the mezzanine rack and medium rack, As to the shape of the car special part, we could design the rack for you, so they can be divided into ,tyre rack,glass rack, front suspender rack, tailpipe rack, muffler rack, etc.





该货架立柱和底座采用模具一体成型的专用型钢，配合高强度悬臂，结构稳固，载重能力强，适用于存放各种长形物料，如型材，管材，板料等。若要放置圆形物品时，在臂端装档杆以防止货物滑落。

Cantilever racking is composed of upright post, cantilever arm and bracing. It is ideal for storing long, unwieldy items. Each kind of rack provides a wide range of flexibility and add-on capability. This is achieved by eliminating obstructions in the front of the rack and providing a clear opening in the front of the rack in lengths as long as desired.



重量型横梁货架

HEAVY DUTY PALLET RACKING

横梁承载能力(kg)

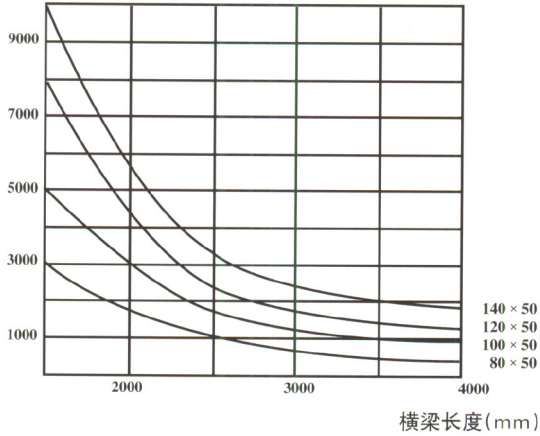

柱片承载能力(kg)

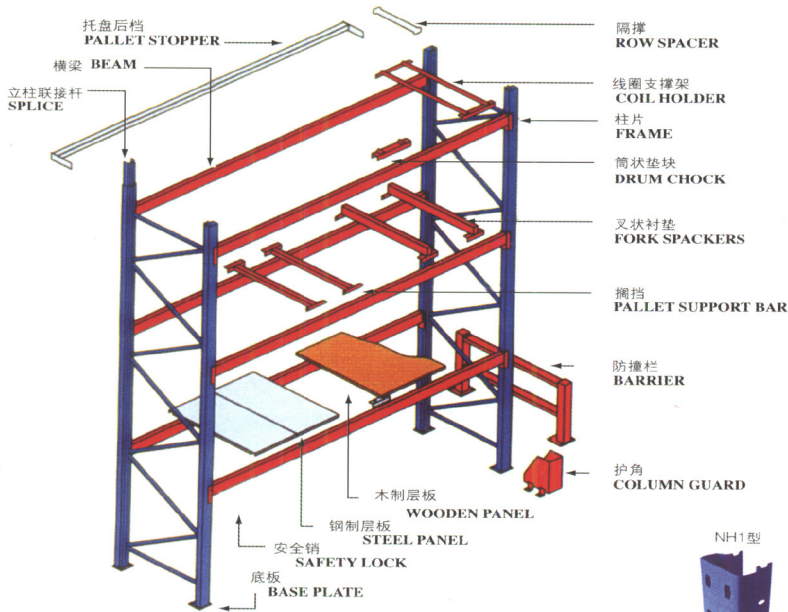
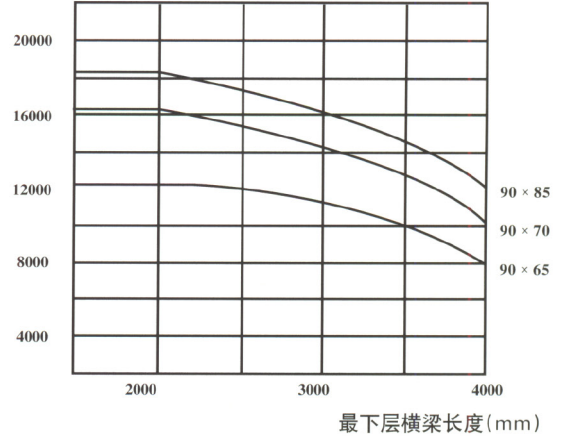

常用横梁规格系列(A): USUAL BEAM SECTION A SERIES

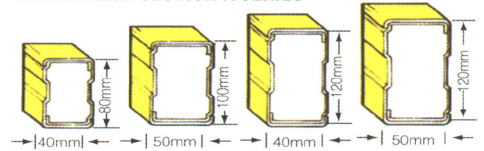

常用横梁规格系列(B): USUAL BEAM SECTION B SERIES

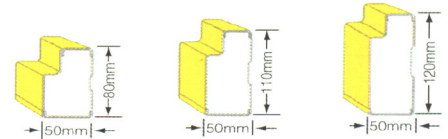

※非规格 b=40-55,h=80-150
NON-STANDARD SERIES

立柱规格系列: POST SECTION SERIES

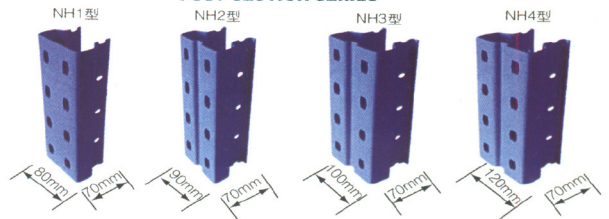

立柱与横梁的连接
CONNECTION

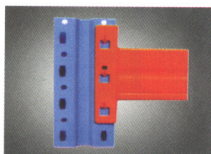

立柱与横梁的连接
CONNECTION

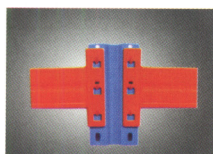

捆挡 A
SUPPORT A

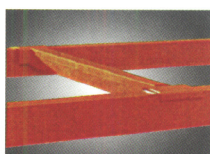

捆挡 B
SUPPORT B

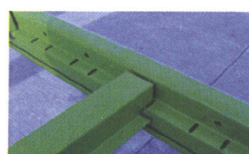

立柱对接
SPLICE OF POSTS

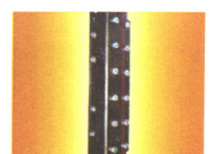

重型横梁式货架:

横梁式货架是使用最普遍的一种货架，提供100%的存取性，并且有很好的拣取效率，但货位式货架的储存密度较低，需要较多的巷道。通常使用3-5层，货架高度受限，一般在10米以下，适用于一般叉车存取。可任意调整组合，安装简易、费用经济，出入库存取不受物品先后顺序的限制。按照货架存取巷道的宽度，区分为传统式巷道、窄道式巷道（需配合适当型式的叉车使用）。

Products: As most commonly used shelf, weight type racking can pick goods efficiently. Fixation and lower density storage, storage heavier items should be piled high with pallets and to use, it is also known as Pallet Rack (Pallet Racking).

Shelves in the selection of heavy-duty, to take into account the size of pallets, weight and stacking the layers to determine the appropriate size the pillars and beams. Moreover, in order to improve space utilization, channel width can be reduced, with special forklift driving on the track, so that the vertical storage space, that is to become alleys Rack (VNA).

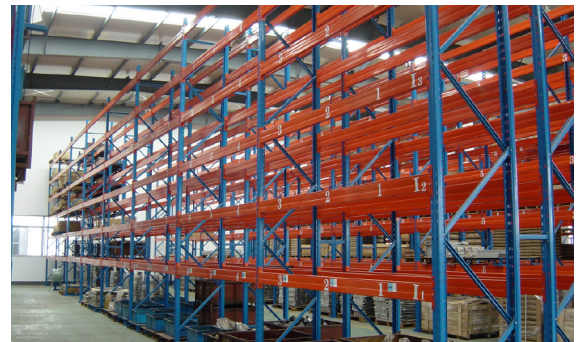

重型横梁式货架:

- ◇ 满足更大的承载要求，最高高度可达16米
- ◇ 以75mm为节距调整横梁间的位置，更好的满足仓储货物的要求
- ◇ 如果有部件在使用中被损坏，可以很方便的更换
- ◇ 货架表面经过处理，具有很高的抗腐蚀能力
- ◇ 可以选用更丰富的配件及安全附件
- ◇ 组装式框架结构，安装简易，快捷
- ◇ 构件部分使用优质原料，焊接牢固，安装紧密
- ◇ 完善的配件体系，适用于各种特殊需要



Heavy Duty Pallet Rack

- ◇ The beam position could be adjusted by the step 75mm, and could better reach the warehouse storage requirements.
- ◇ If there is any parts got damaged, it could be changed conveniently.
- ◇ The racking surface has been treated, to get has high corrosion-proof ability.
- ◇ Could choose more various parts and safety accessories.
- ◇ Assembling structure, the rackings could be installed easily and speedily.
- ◇ The parts adopt high quality material, and could be soldered firmly, installed closely.
- ◇ Perfect accessories system, could meet in various special demands.





产品特点:

货架立柱面和立柱架均采用优化结构，其承重强度比普通结构高达25 IX。

The upright section and frame of this rack uses the optimized structure, loadbearing strength is 25 IX than the common structure.

横梁采用双C型组合，闭口箱形结构，抗腐蚀能力强，充分发挥钢材强度的特色，单元货格承重5000kg以上。

The beam uses double "C" combination, closed box structure, and ensures goods performance resistance to torque, full protection against corrosion, fully bring into play the advantage of the steel strength, the maximum bearing capacity of unit rack may reach over 5000kg.

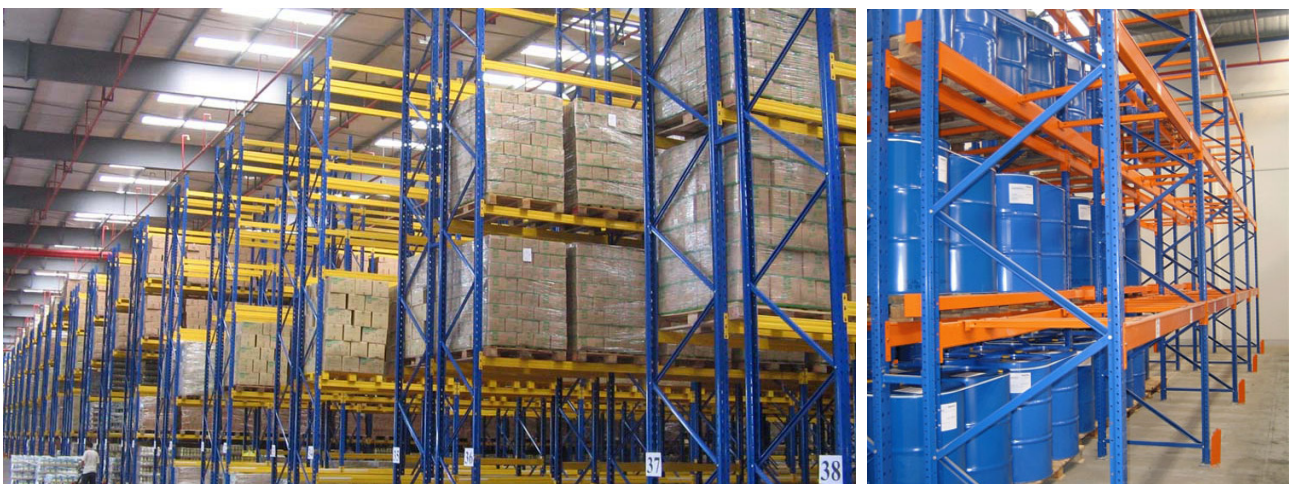

阁楼式货架，以其双层或多层独特设计，充分利用仓库的上部空间，大大增加储位数量，在空间利用率有着得天独厚的优势。

我公司生产的阁楼货架，其结构同中型货架一样方便快捷，具有中型货架的一切优势，如结构设计简单，层板可调，无需焊接；外观眩亮，简洁美观，极具现代感。

Mezzanine, multi-tier structure, make full use of high ware-house to improve the storage sufficiency. WAP could provide mezzanine of painted 50*42 upright. Both owns similar installation features like easy assembly, boltless construction, flexible adjustment, quick delivery and bright surface.



阁楼式货架设计依据:

- 1 货架要求（尺寸、承载量等）
- 2 库房可用净高及照明
- 3 楼面承载
- 4 存取货物方式及物流方向

The base of multi-Layer racking design:

1. Requiring of rack (size, load)
2. The height of the ware house
3. The load of floor
4. The means of picking goods and logistic case





整体组装，无须现场焊接。通常承载能力在300KG-1000Kg/M²，立柱选择承载能力强、用钢量少的圆管或方管；主次梁可以根据承载需要选择目前在钢结构工程中最经济合理的H型钢及C型冷弯成型梁；楼面板选用花纹钢板或镂空板，采用扣板式结构，与主次梁刚性固定，整个平台结构整体性强，可以根据实际需要选择不同的楼面板以满足消防活防灰尘、防小件坠落要求。楼面下方也可根据需要配置照明系统。货物输送可选择液压升降平台、货梯或叉车。

Usually consist of pipe post, girder, deck, hand-rail and staircase etc. Load capacity usually within 1000kg / square meter. The key benefit of a Mezzanine is the ability to create new space fast and efficiently. Maximize the total cube area of your facility as an alternative to a costly building addition or even as alternative to moving premises. Mezzanines floor make use of vertical space which would otherwise go unused. It can convert the space into usable storage, production or office area at a fraction of the cost of new construction.

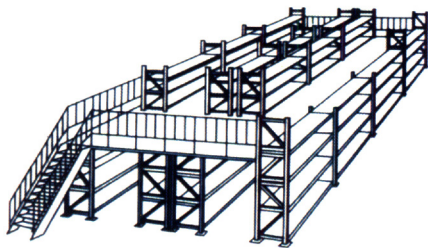

阁楼货架

Mezzanine Rack

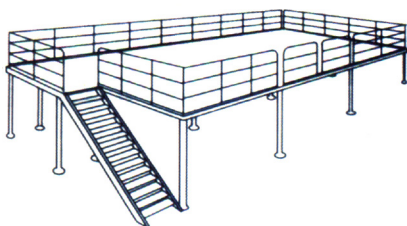

钢结构平台

Steel Platform



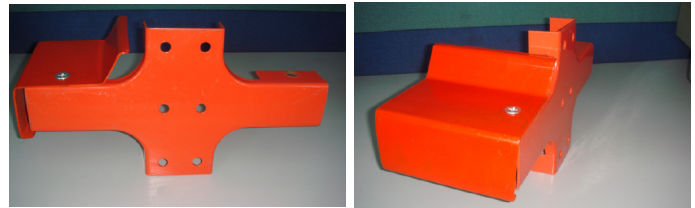

适用于储存品种较单一，叉车可直接进入货架内作业，货物进出可实现先进先出，库房空间利用率达80%

DRIVE-IN RACKING:

It is Suitable for the onefold variety of storage breed, fork lifter can go into the shelves for work, the goods can realize the first in and first out, the using rate of the warehouse space reaches 80%.



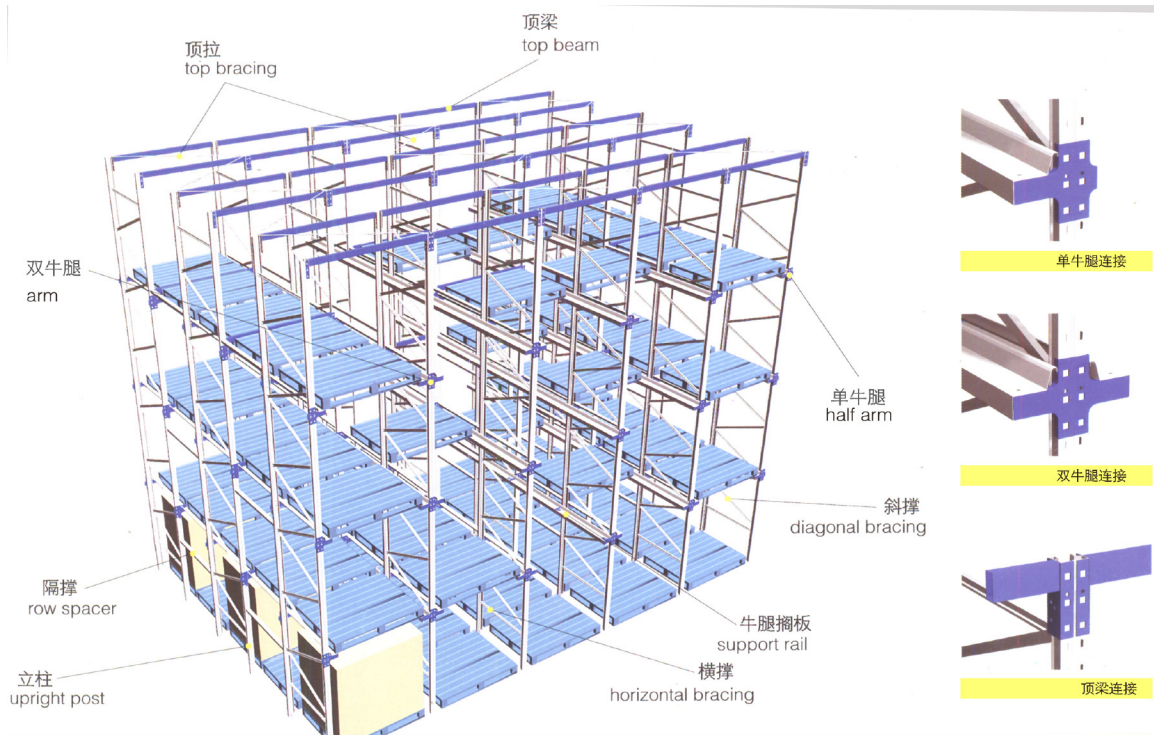

贯通式货架又叫驶入式货架或通廊式货架，利用最小的空间提供最大的存储量，尤其适用于大批量、小品种货物的存储作业，叉车可直接驶入货道内进行存取货物，作业极其方便。

The Drive-IN.Through systems provide you maximum storage capacity with minimum amount of space.It is suited for large quantities,limited order picking etc.Fork lift drives into the racking for storing or picking goods.



流利式货架，是将货物置于滚轮上，利用一边通道存货，另一边通道取货。料架朝出货方向向下倾斜，货物在重力作用下向下滑动。可实现先进先出，并可实现一次补货，多次拣货。流利架存储效率高。适合大量货物的短期存放和拣选。

流利货架上的常用容器有周转箱，零件盒及纸箱。周转箱和零件盒两种标准容器中，以周转箱更常使用。故在制定流利架标准规格时，以可堆式周转箱为参照。

Roller racking is a special racking system depending on rollers to make products stored moving from the entry side to the picking end under the force of Gravity. It is a kind of FIRST-IN FIRST-OUT racking and also could make high density of storage. This kind of racking is useful for short-time storage and processing of items.





用于存放中小型模具、顶部选配手拉葫芦移动车，便于模具的起吊和存放，抽屉下设置有滚轮轨道，使重载后依然能用很小的力轻松拉动。通常每层承载量小于800kg。

Suit of middle and light die deposition ,equiped with trandfer car the top and many limiting set to assure lifting easily and safely.Four roller are installed under the to make the removing easily.Usually using load is no more than 800kg.



窄巷式托盘货架是为新一代仓库设计，配合使用专业叉车，以导轨或滑触线导向操作，操作高度可达20米。其存储量大，提取货物快速方便。

Very Narrow Aisle(VNA) pallet racking systems are designed to meet the new generation of warehouse. Operates with guide rails or wire induction guidance system with specialized reach truck operates to the height of about 20m. Large storage capacity and fast picking rate.



围网 / 背网

MESH NET/BACK MESH





主要适用于品种少，批量大货物储存，货物在倾斜的滚子架上自动由进货端输送至出货端，储存迅速，先进先出，库房空间利用率高达80%托盘先进先出，适用于大批同类货物的存储，空间利用率较高。

Working on a first-in, first-out basis, Gravity racking provides extremely high levels of storage density in a given area. Pallets are loaded onto dedicated lanes of inclined gravity rollers which are set at a fixed gradient. When a load is taken from the picking face, the next pallet rolls into position, with replenishment stock loaded at the opposite (upper) end of the lane.

推入式货架

BOOSTING RACKING

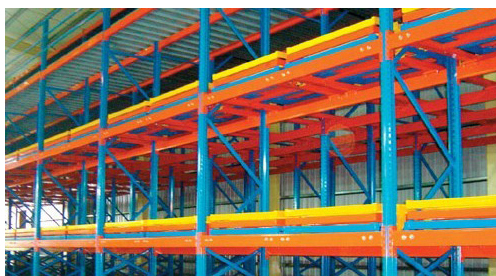
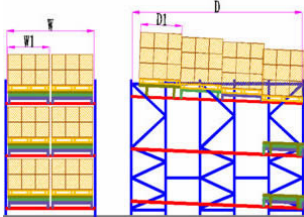

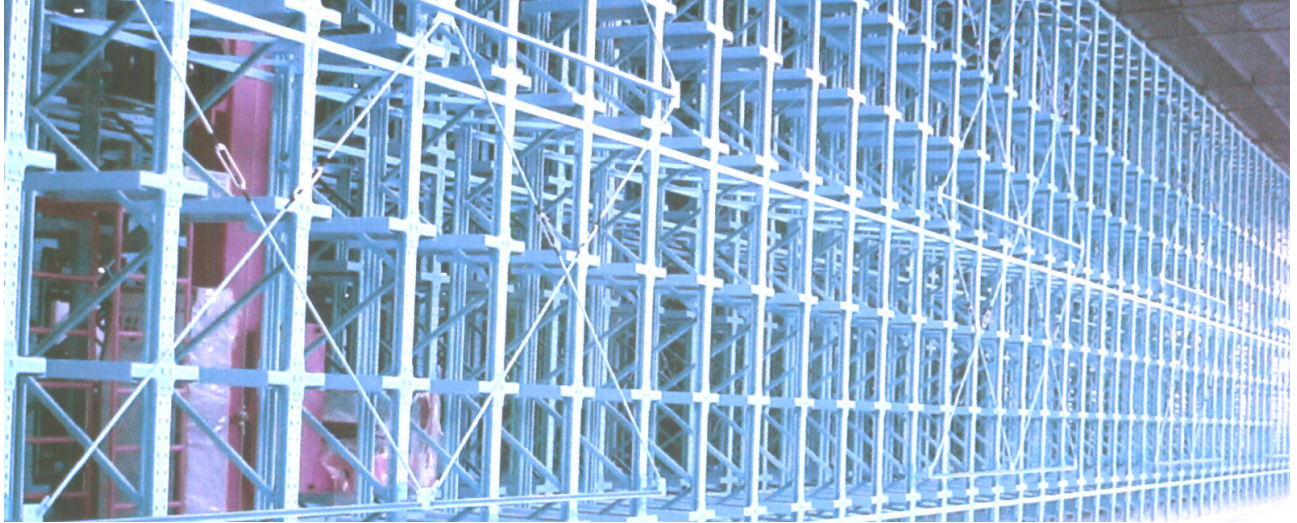

装配式或焊接式货架系统，配以堆垛机、输送系统、计算机管理控制系统，可以产现充分利用空间、搬运存取机械化、贮存管理现代化的功能。

The AS/RS System consists of assembly recking and welding racking. Complemented by passage stackers, conveyance system and computer control system, it guarantees the fullest space utilization, handling mechanization and storage management modernization.

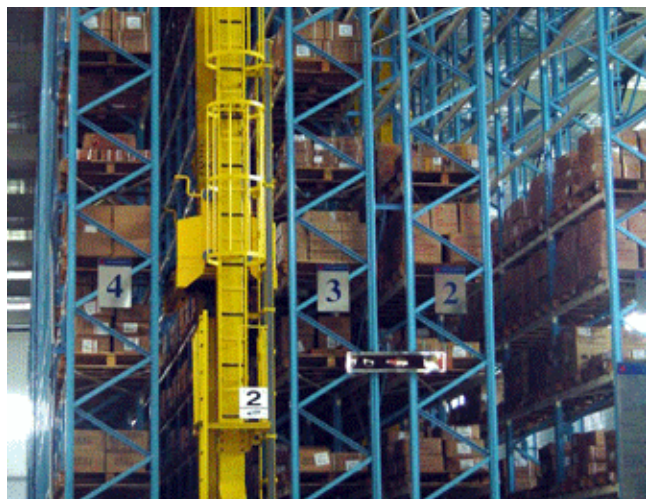
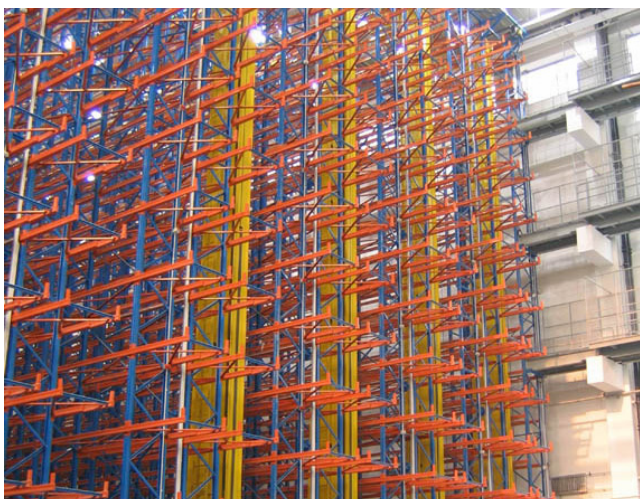
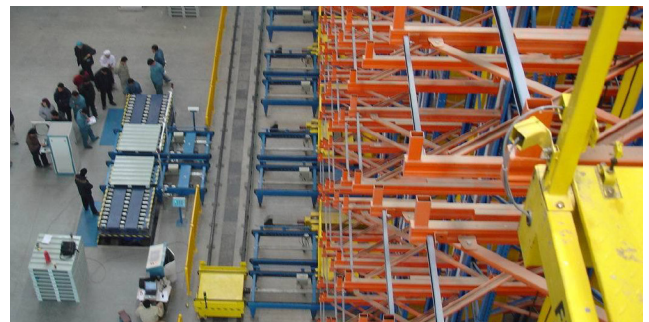

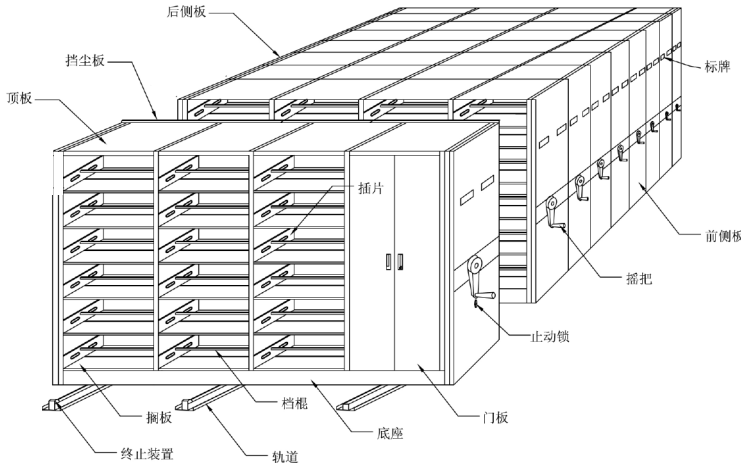

与固定货架存储方式不同，移动式货架只用一条在需要进入时才打开的通道，从而在给定的空间内，大大提高了存储密度。这种方法能使存储提高100%以上，使有限空间得到更充分地利用，

Compared with fixed pallet racking, movable racking needs one aisle for picking and loading to make full use of the storage space.



储物柜 STORAGE CABINET



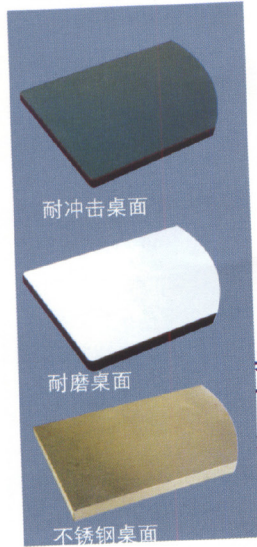

耐冲击桌面

耐磨桌面

不锈钢桌面

桌面材料

适合模具、钳工、检测、维修、组装等各种不同用途使用。
组合式设计，拆装容易的。
结构坚固，平均荷重 1000 公斤。
有耐冲击桌面、耐磨桌面及不锈钢桌面可供选择。
可加调整脚调整水平，可调整高度 30m/m。

MINGSHENG heavy duty assembly work bench allow custom-made to all geometric requirements of the modern work area.
MINGSHENG work bench with strong construction and the worktop is smoothed and impregnated, it maximum loading capacity 1000kg
The workbench legs are made from steel profile and legs level designed allow floor level adjustable

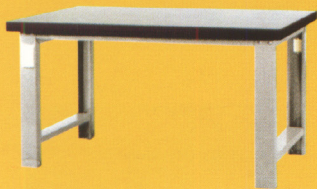

★ WA-57 ★ WA-57F ★ WA-57S
SIZE: H800 × W1500 × D750
★ WA-67 ★ WA-67F ★ WA-67S
SIZE: H800 × W1800 × D750
★ WA-77 ★ WA-77F ★ WA-77S
SIZE: H800 × W2100 × D750



★ WAL-5023 ★ WAL-5203F
SIZE: W1500 × D750 × H800
★ WAL-6203 ★ WAL-6203F
SIZE: W1800 × D750 × H800
DRAWER: 105m/m × 3



★ WAL-5023-1 ★ WAL-5203F-1
SIZE: W1500 × D750 × H800
★ WAL-6203-1 ★ WAL-6203F-1
SIZE: W1800 × D750 × H800
DRAWER: 105m/m × 3



★ WA-57+WQ52 ★ WA-57F+WQ52
SIZE: H1400 × W1500 × D750
★ WA-67+WQ62 ★ WA-67F+WQ62
SIZE: H1400 × W1800 × D750



★ WAL-5023+WQ56 ★ WAL-5203F+WQ56
SIZE: W1400 × D1500 × H750
★ WAL-6203+WQ66 ★ WAL-6203F+WQ66
SIZE: W1400 × D1800 × H750



★ WAS-57+WQ53 ★ WAS-57F+WQ53
SIZE: H1400 × W1500 × D750
★ WAS-67+WQ63 ★ WAS-67F+WQ63
SIZE: H1400 × W1800 × D750



EA-7042M; H865 × W566 × D600
EB-7042M; H865 × W718 × D600
DRAWER; 100mm × 2 · 150mm × 1 · 250 × 1

EA-10074M; H1165 × W566 × D600
EB-10074M; H1165 × W718 × D600
DRAWER; 50MM × 1 · 75mm × 1 · 100mm × 2
125MM × 1 · 200mm × 1 · 250mm × 1

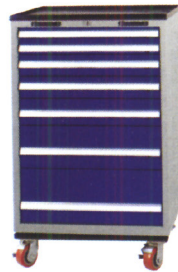

EA-7041M+KQ5655; H1395 × W566 × D600
EB-7041M+KQ7155; H395 × W718 × D600
DRAWER; 100mm × 2 · 200mm × 2
PERFORATED PANEL KQ-5655;
H550 × W560(附三角固定架)
KQ-5655; H550 × W560(附三角固定架)



★ WAS-54022 ★ WAS-54022F WAS-54022S
SIZE; H800 × W1500 × D750
★ WAS-64022 ★ WAS-64022F WAS-64022S
SIZE; H800 × W1800 × D750
★ WAS-74022 ★ WAS-74022F WAS-74022S
SIZE; H800 × W2100 × D750
DRAWER; 100mm × 1 · 20mm × 1



★ WAS-57042 ★ WAS-57042F WAS-57042S
SIZE; H800 × W1500 × D750
★ WAS-67042 ★ WAS-67042F WAS-67042S
SIZE; H800 × W1800 × D750
★ WAS-77042 ★ WAS-77042F WAS-77042S
SIZE; H800 × W2100 × D750
DRAWER; 100mm × 2 · 150mm × 1 · 150mm × 1



★ WAS-57042+WQ53 ★ WAS-57042F+WQ53
SIZE; H1400 × W1500 × D750
★ WAS-67042+WQ63 ★ WAS-67042F+WQ63
SIZE; H1400 × W1800 × D750



★ WA-67+WQ67 ★ WA-67F+WQ67
SIZE; H1360 × W1800 × D750



★ WA-6703+WQ67 ★ WA-6203F+WQ67
SIZE; H1360 × W1800 × D750

HANGER RACK /
CART

物料整理架
Hanger rack



推车/登高车

Trolley/Ladder Trolley





巧固架:

Unit rack features:

配合机械化搬运设备, 可使用在物流供应链的各个环节。
在巧固架不存放物品时, 可互相插入存放(固定式)
或拆卸后存放(可拆式), 不占空间。

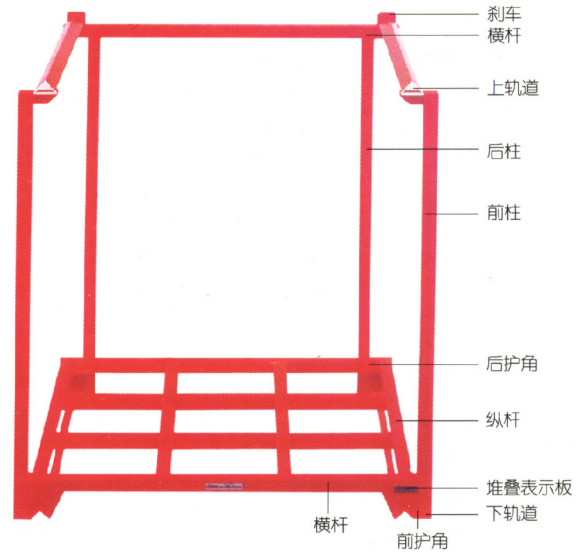

标准规格

型号	外形尺寸(mm)			内尺寸(mm)			自重kg	荷重T
	宽度(W)	深度(D)	高度(H)	宽度(W)	深度(D)	高度(H)		
P001	1350	1200	1200	1250	1150	1000	62	1
P002	1350	1200	1400	1250	1150	1200	65	1
P003	1450	1200	1200	1350	1150	1000	64	1
P004	1450	1200	1400	1350	1550	1200	66	1
P005	1550	1200	1200	1450	1150	1000	65	1
P006	1550	1200	1400	1450	1150	1200	68	1

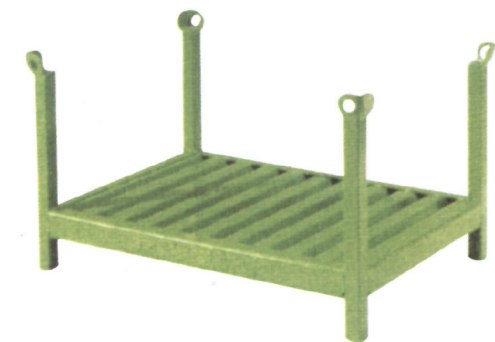
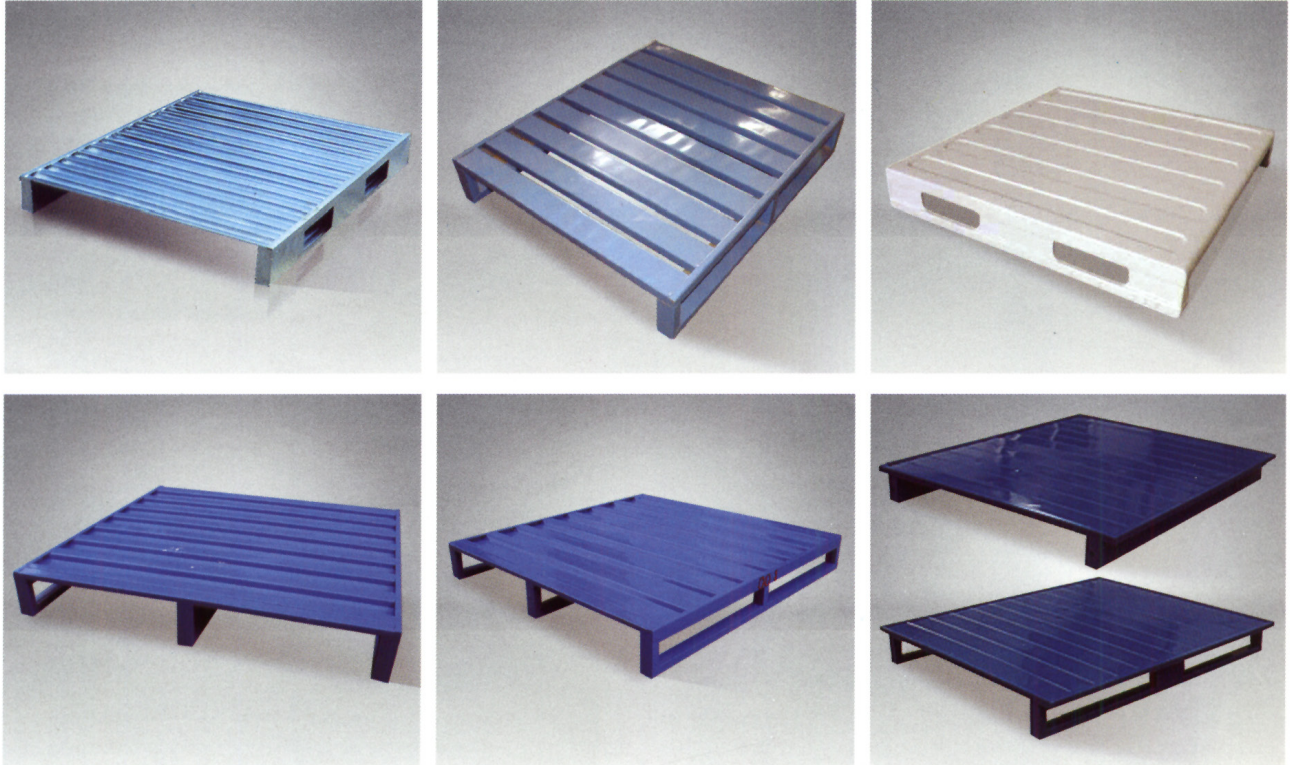

钢制托盘选用表

THE TYPE OF STEEL PALLETs

规格 size(mm)				承载(kg) capacity
宽(W)	深(D)	高(H)	叉腿高(H)	
800	800	120	90	500
1000	1000			2500
1200	1200	150		



超轻金属托盘是明盛开发的生态环保型运输、仓储、包装用托盘。其采用镀锌钢板制成，环保100%，可以在回收利用。特别适用于出口，不需要熏蒸、高温消毒或者防腐处理。我明盛可以生产不同规格的金属托盘，也可以按客户的要求定做。稳定的包装性能符合国际环保法规，防水防潮防锈，是物流储运中的最佳选择。

托盘是有使用方便、灵活、坚固耐用的特点，是仓储、运输业广泛使用的消耗品。托盘常见规格为100x100cm(国际标准)、110x110cm、120x80(韩国、中国标准)、120x120cm等。

Light Metal Pallet is made of galvanized steel pallet, it is better for export, do not need to fumigate and anticorrosive, we could do all kinds of size, the weight is only one third of wooden pallet, so it is best choice for all of us.



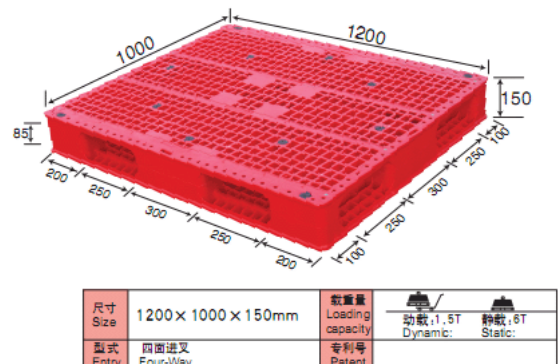
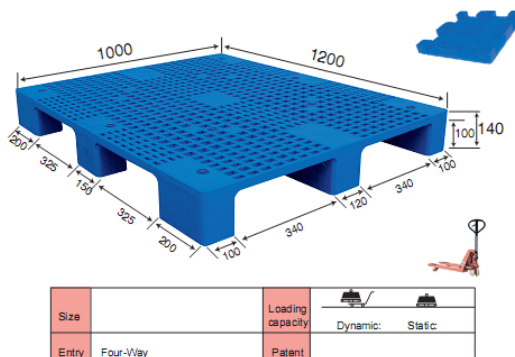
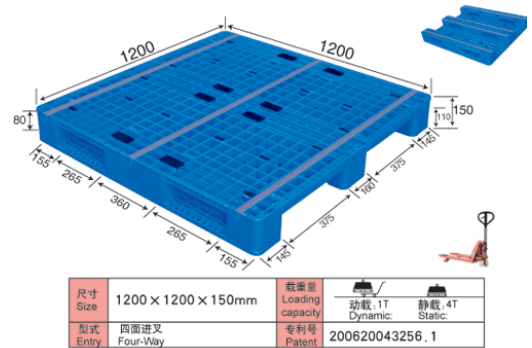
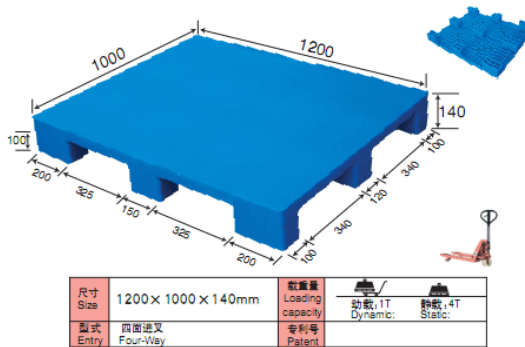
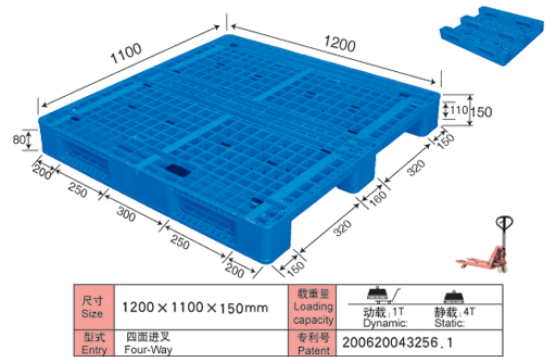
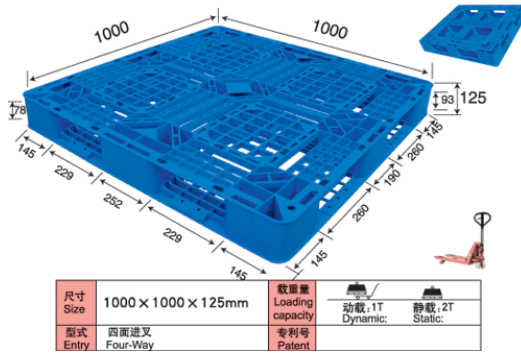
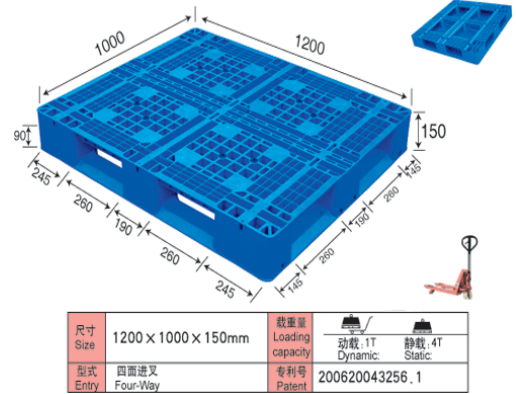
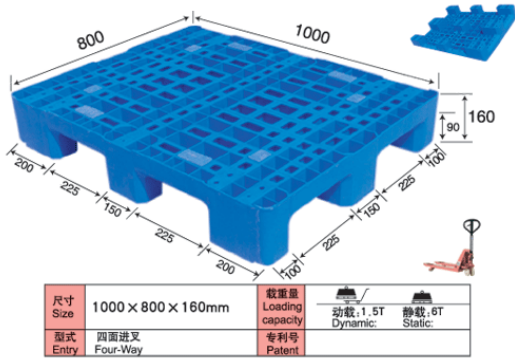

平台钢格板

平台钢格板应用范围极其广泛，一般工厂、车间、矿业、港口的各类平台都可选用，美观气派，安装方便，是一种更新换代的新型建筑产品。我公司生产一百多个型号的钢格板供客户选用。

可在钢格板周边增焊踢脚板（挡边板）、花纹板护板、安装连接件等附件。

可采用与钢格板负载扁钢不同规格的扁钢包边，或用角钢、槽钢、方管等包边。

可在需经学移动或打开的钢格板上安装把手和铰链。

平台钢格板的包边焊接标准：系列1每五条焊一条；系列2每四条焊一条；系列3每三条焊一条。焊缝为不小于3mm的单面角焊，焊缝长20mm。

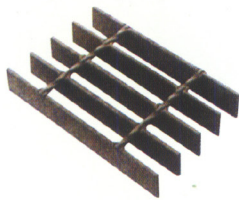

普通平面型

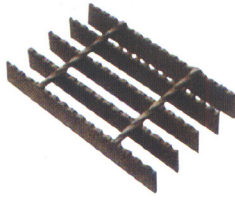

防滑齿形型

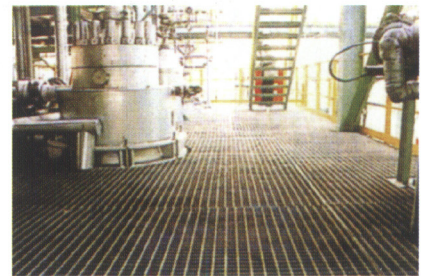

楼梯踏步板

我公司生产的踏步板可根据有无前护板和与梯梁联接方式有四种形式，表示为ST1、ST2、ST3、ST4。

从经济角度考虑，建议尽可能采用模数宽度（系列1采用125、155、185、215、245、275，系列2采用125、165、205、245、275mm等）和100mm倍娄长度（如500、600、700、800、900、1000、1200mm等）。

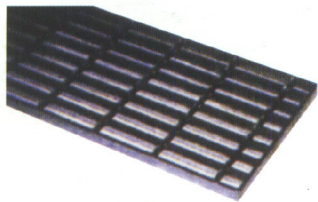

ST1 焊接固定，无前护板



侧板用65×5的扁钢Ø14螺栓孔各一个，仅在客户需要时才倒角，以适应斜梁

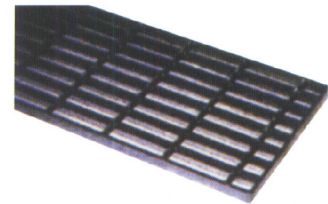

ST2 螺栓固定，无前护板

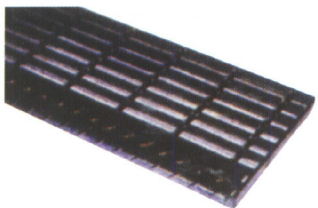

ST3 焊接固定，无花纹板，前护板

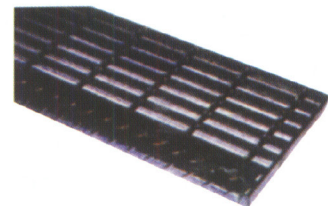

ST3 螺栓固定，有花纹，前护板

推荐楼梯踏步板宽度

ST1、ST2、ST3、ST4、扁钢中心间距30mm		95	125	155	185	215	245	275
扁钢中心间距40mm	ST1							
	ST2		125	155	205	245	285	
	ST3							
	ST4		115	155	195	235	275	
螺栓孔中心距A(mm)		45		75		100		150

注：扁钢厚5mm

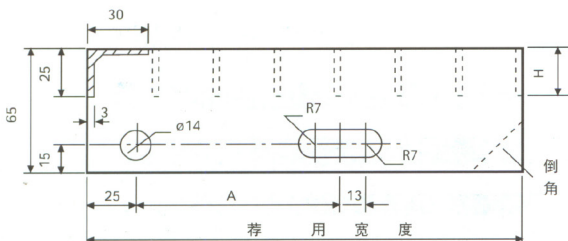



内饰件周转架



轮胎周转架

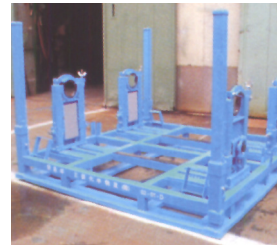

圆筒件周转架

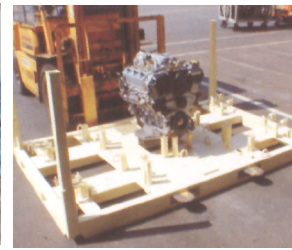

发动机周转架



钢托盘

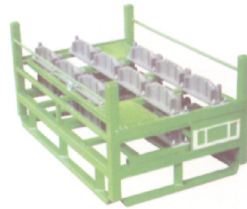

发动机钢体周转架



可堆叠铁板箱



发动机周转架



废料箱



发动机储运箱



周转架



可折叠金属周转架



底梁专用储运架



线束周转架



汽车玻璃周转架



可折叠料箱

专用非标物流器具特点:

1. 折叠后堆叠, 降低回收运输成本;
2. 多层立体堆叠, 充分利用空间, 减少占地面积;
3. 专业工装设计, 解决不规则形状工件的搬运难题;
4. 改善作业环境; 提高存储效率;
5. 确保产品在运输和存储环节中无损耗;

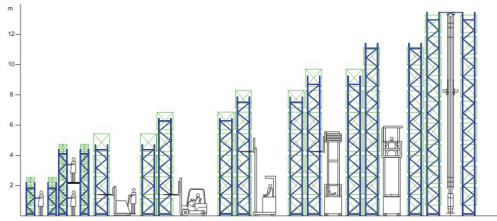

三轮电动拖车头
TBS20-TBS60
Tri-wheel electric tow truck



四轮电动拖车头
TB50-TB100
Four-wheel electric tow truck



前移立式电动叉车
FBR10-FBR30
Reach type stand battery stacker



重载型电动堆高机
PBS16N-PBS20N
N series battery pallet stacker



前移式电动堆高机
RBS10-RBS20
Reach type battery stacker



全电动拖板车
PBT20-PBT40
Battery pallet truck

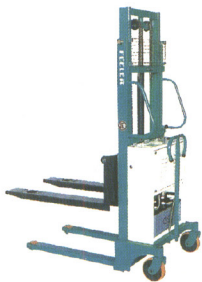

半电动堆高机
SHS-10/SHS-10-1
Sami-powered hand stacker



半电动取料机
SHOP-02/SHOP-03
Sami-powered order picker



半电动油桶搬运车
Hydraulic electric
Turnover barrel machine



液压升降平台
Hydraulic lift table



液压托板车
HPT-20/HPT-30
Hand pallet truck

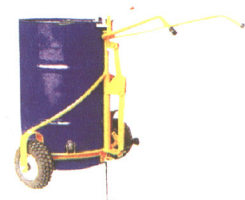

液压油桶搬运车
Oil barrel transports cart

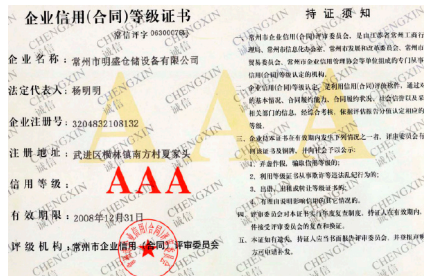

CUSTOMER

主要客户

宁波钢铁有限公司
麦格纳动力总成(常州)有限公司
江苏舜天服饰有限公司
今创集团有限公司
嘉兴西互制动系统有限公司
常州华威电子有限公司
现代(江苏)工程机械有限公司
常州信力燃气设备有限公司
永祺(常州)车业有限公司
常州士林机电有限公司
常发集团-常州凯越机械有限公司
无锡富星地毯有限公司
安必克阀门有限公司
北京现代(常州)汽车销售服务有限公司
江苏柏伦宝船业有限公司
江苏兆胜空调有限公司
中国南车集团戚墅堰机车车辆工艺研究所
高划电线制造(奉化)有限公司
苏州和诚别克汽车销售服务有限公司
如新(中国)日用保健品有限公司湖州分公司
江苏清拖农业装备有限公司
张家港森通汽车销售服务有限公司
深圳振豪密封技术有限公司上海分公司
宁波思澄净水设备有限公司
雪弗莱汽车(常州)销售服务有限公司
善尔固(无锡)汽车特种橡胶配件有限公司
嘉善海力达工具有限公司
常州天宁丰田汽车销售服务有限公司
江苏好收成韦恩农化股份有限公司
浙江美科斯叉车有限公司
日新电机(无锡)电力电容器有限公司
贝内克长顺汽车内饰材料(张家港)有限公司
常州华阳万联汽车附件有限公司
罗斯-罗伊斯船舶制造(上海)有限公司
鸿联集团-常州裕丰家具有限公司
常州义力科正传动设备有限公司
台湾新莊国际贸易有限公司
常州民力轴承有限公司
常州对外经济技术贸易(集团)公司
常林股份有限公司
苏州合骏电子应用材料有限公司
片山传动(常州)有限公司
江苏高能齿轮箱有限公司

东海橡塑(合肥)有限公司
吴江竞荣(美国)怡达电气有限公司
上海安科瑞电气有限公司
张家港波坦建筑机械有限公司
查特中汽深冷特种车(常州)有限公司
常州康辉医疗器械有限公司
无锡市永凯达齿轮制造有限公司
英国独资常州格力博工具有限公司
杭州钢铁股份有限公司
常州市莱赛激光工程有限公司
南亚电子材料(昆山)有限公司
浙江三叶富新机车有限公司
博尔豪夫(无锡)紧固件有限公司
无锡赛威特燃烧器制造有限公司
爱森(中国)絮凝剂有限公司
无锡惠曼精密机械有限公司
长安福特汽车有限公司南京公司
青岛金王应用化学股份有限公司
立达(常州)纺织仪器有限公司
住化电子材料科技(无锡)有限公司
常通别克汽车销售服务有限公司
江苏烟草公司常州分公司
嘉汇恒合石膏建材(常州)有限公司
伟创力电子(常州)有限公司
高绿精密科技(无锡)有限公司
瓦锡兰推进装置(无锡)有限公司
常州市武进南方轴承有限公司
无锡纽耶拉轮胎再生技术有限公司
索玛(上海)自动化系统有限公司
无锡汽车车身有限公司
南通华都一龙空调制造有限公司
江苏舜天梦岛时装有限公司
常州金田汽车(广州本田)汽车销售服务有限公司
青岛海尔住宅设施有限公司上海分公司
嘉兴市诚峰金属制品有限公司
常州平安汽车销售服务有限公司
常州顺风发电设备有限公司
福莱斯乐摩擦(平湖)有限公司
上海大众汽车有限公司
无锡泰铭电子有限公司
苏州东昌隆墙体材料科技有限公司
常州市科信燃气设备有限公司
常州市天晟塑胶化工有限公司

浙江金棒运动器材有限公司
上海崇明电力有限公司
长春三鑫工艺装备有限公司
江苏安格特新材料科技有限公司
常州依维柯电子有限公司
无锡中策减震器有限公司
浙江安吉大名家家具有限公司
苏州三星电子电脑有限公司
增城市顺龙高尔夫球制品有限公司
南通恒康海绵制品有限公司
上海恒力电源设备有限公司
杭州世宝汽车方向机有限公司
徐州华远燃控科技有限公司
威刚科技苏州有限公司
国光电器股份有限公司
江苏瑞帆环境工程设备有限公司
南京汽车内饰材料厂
江苏舜天奥斯福制衣有限公司
张家港塞德瓦船用设备有限公司
中华恐龙园有限公司
无锡小天鹅进出口有限公司
里戈勃劳伊特新亚电机有限公司
常州同大气雾有限责任公司
广东国华粤电台山发电有限公司
普利司通(常州)汽车配气有限公司
常州老三集团
常州海杰冶金制造有限公司
玉柴重工(常州)有限公司
江苏华东民茂机械有限公司
江苏华东机房集团有限公司
盖茨液压技术(常州)有限公司
常州和方标准件有限公司
江苏浩峰汽车附件有限公司
马丁传动件(常州)有限公司
江苏黑牡丹集团股份有限公司
丹阳林泉汽车装饰件有限公司
江苏贝孚德通讯科技股份有限公司
江苏盐业阀门有限公司
昆山维萨阀门有限公司
上品兴业氟塑料(嘉兴)有限公司
常州伟泰精密机械有限公司
无锡伟拓轨道交通车用车空调制造有限公司



明盛仓储

MING SHENG

常州市明盛仓储设备有限公司

地址: 常州市武进区横林工业园横洛路23号

电话: 0519-88786788 88787978 88499097 (总机)

传真: 0519-88780111

Http://www.msjscn.com

E-mail: company@msjscn.com

往常州、南京

横山桥

往南京

沪宁高速

锡澄公路